

LB-OH-650-10-C-7/16FSPO Octave Horn Antenna 1-2GHz 10dB Gain 7/16 DIN Female

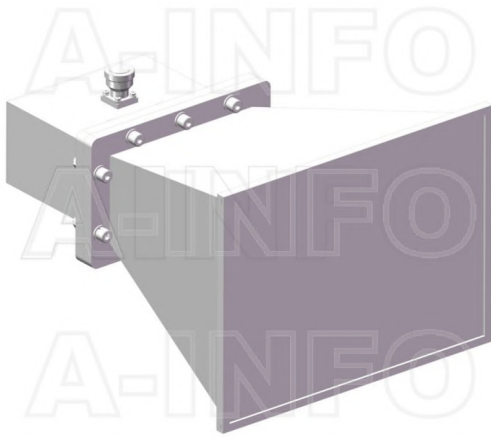

Octave Horn Antenna Operating From 1GHz to 2GHz With a Nominal 10dB Gain With 7/16 DIN Female Connector

Product Information

SKU	LB-OH-650-10-C-7/16FSPO
-----	-------------------------

Description

Octave horn antenna LB-OH-650-10-C-7/16FSPO, operating from 1 to 2GHz with a nominal 10dB gain and low VSWR 1.5:1 with 7/16 DIN Female output connector. The model LB-OH-650-10-C-7/16FSPO has uniform gain through its frequency span, providing efficient performance characteristics and directionality. It can handle 500W continuously and 3000W peak power. Constructed of lightweight corrosion-resistant aluminum, the horn comes with a specially designed weatherproof radome which provides excellent protection against the rain and dust but has very little loss across the full operating frequency band. This octave horn antenna is linearly polarized and ideally suited for EMI testing, direction finding, surveillance, antenna gain and pattern measurements and other applications.

Technical Specification

Electrical Specification		Interface	
Frequency, Min (GHz)	1	Output Type	Coaxial
Frequency, Max (GHz)	2	Connector	7/16 DIN
Gain, Typ (dBi)	10	Connector Gender	Female
Polarization	Linear	Mechanical Specification	
3dB Beamwidth, E-Plane, Min (Deg.)	29	Body Material	Al
3dB Beamwidth, E-Plane, Max (Deg.)	63	Finish	Chemical Conversion Coating, Gray Paint
3dB Beamwidth, H-Plane, Min (Deg.)	29	Size, W (mm)	331
3dB Beamwidth, H-Plane, Max (Deg.)	65	Size, H (mm)	251
Cross Pol. Isolation, Typ (dB)	35	Size, L (mm)	432
VSWR, Typ	1.5:1	Weight, (kg)	3.5
Impedance, (Ohm)	50		
Power Handling, CW, (W)	500		
Power Handling, Peak, (W)	3000		

Additional Information

Application	Outdoor, Waterproof and Dustproof, Fixed	Solution for	Gain Reference Antenna Measurement Far-field Measurement System Intergration
-------------	--	--------------	---

Outline Drawing

7/16 DIN Female Output with Radome (Option, P/N: LB-OH-650-10-C-7/16FSPO, Outdoor Application)

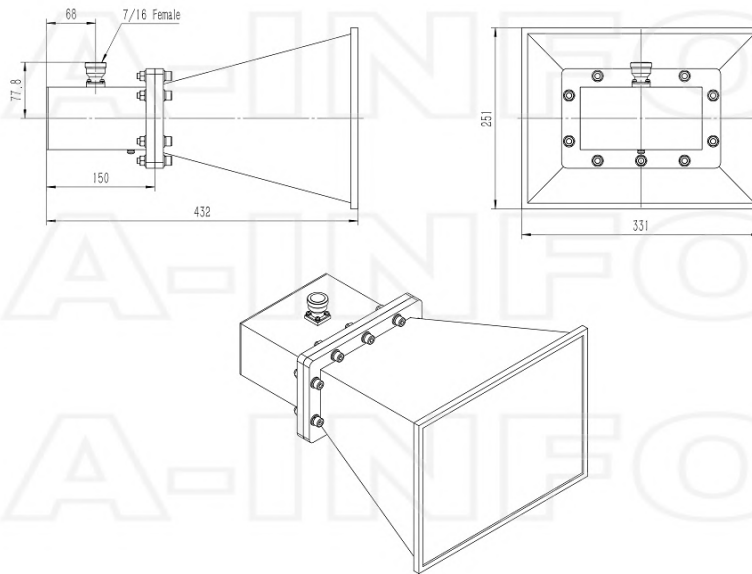

Typical Test Results

Gain

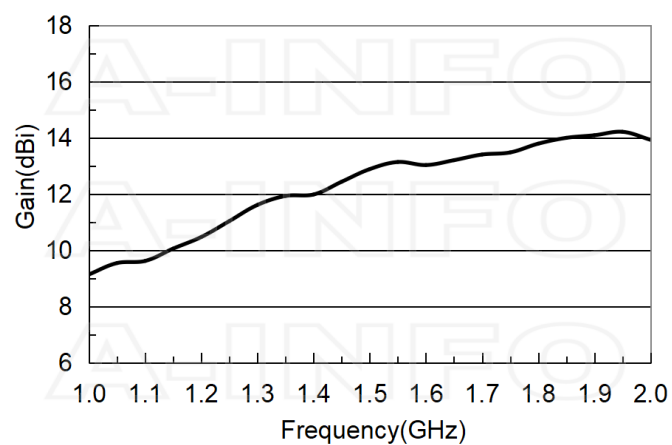

Antenna Factor

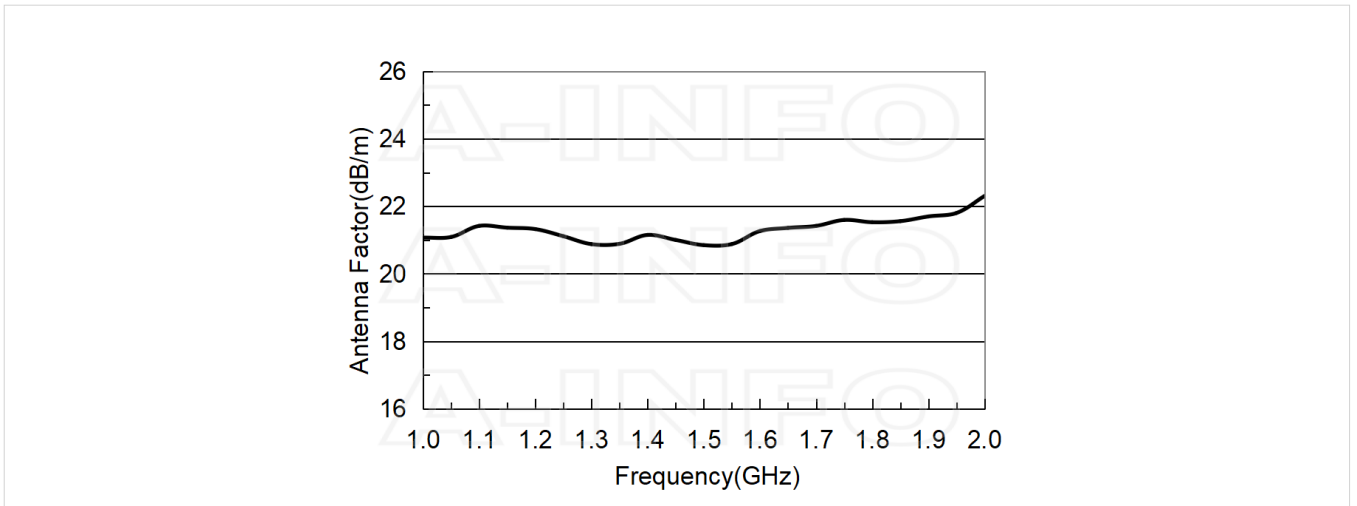

Antenna Factor (Table)

Frequency(GHz)	Gain(dBi)	AF(dB/m)
1.0	9.14	21.07
1.1	9.62	21.42
1.2	10.47	21.32
1.3	11.61	20.88
1.4	11.98	21.15
1.5	12.88	20.85
1.6	13.03	21.26
1.7	13.40	21.42
1.8	13.79	21.53
1.9	14.09	21.70
2.0	13.93	22.30

Cross Polarization Isolation

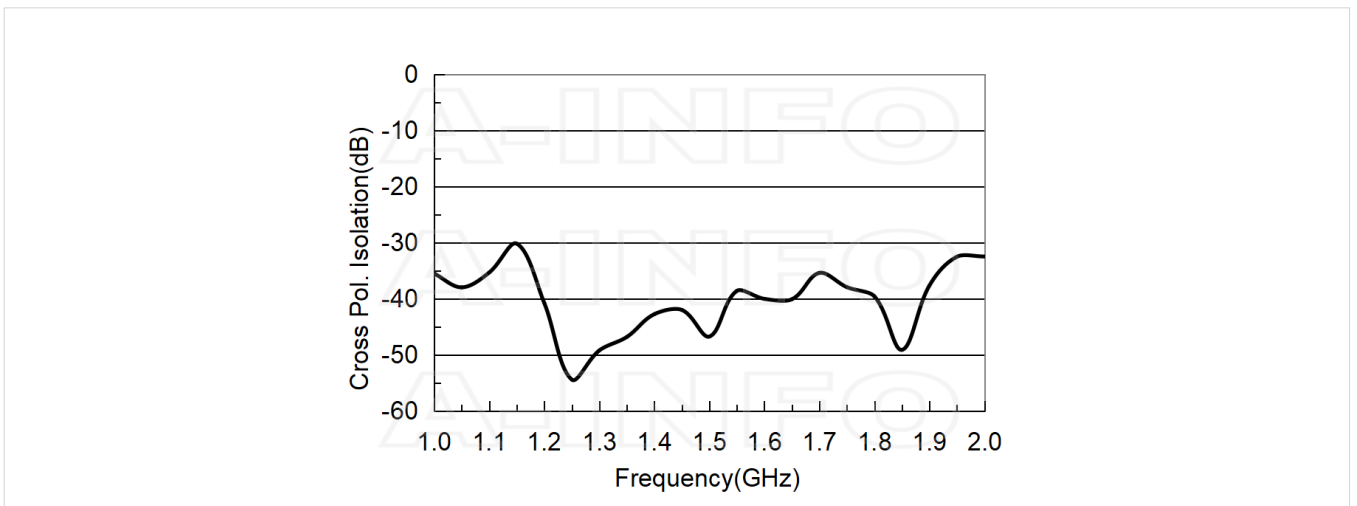

VSWR

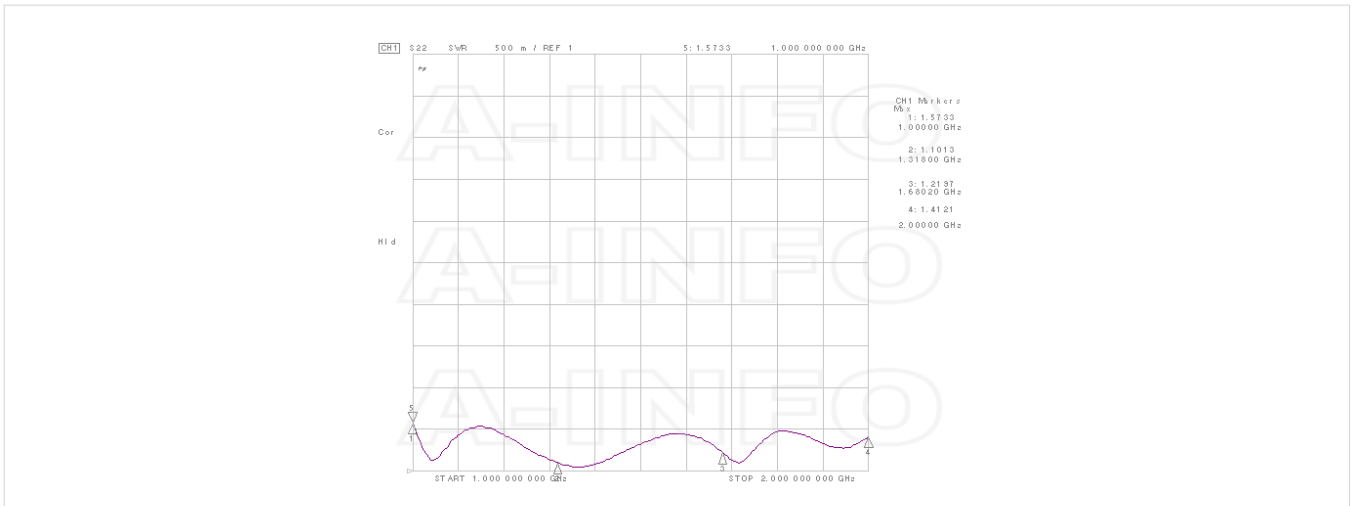

Beamwidth

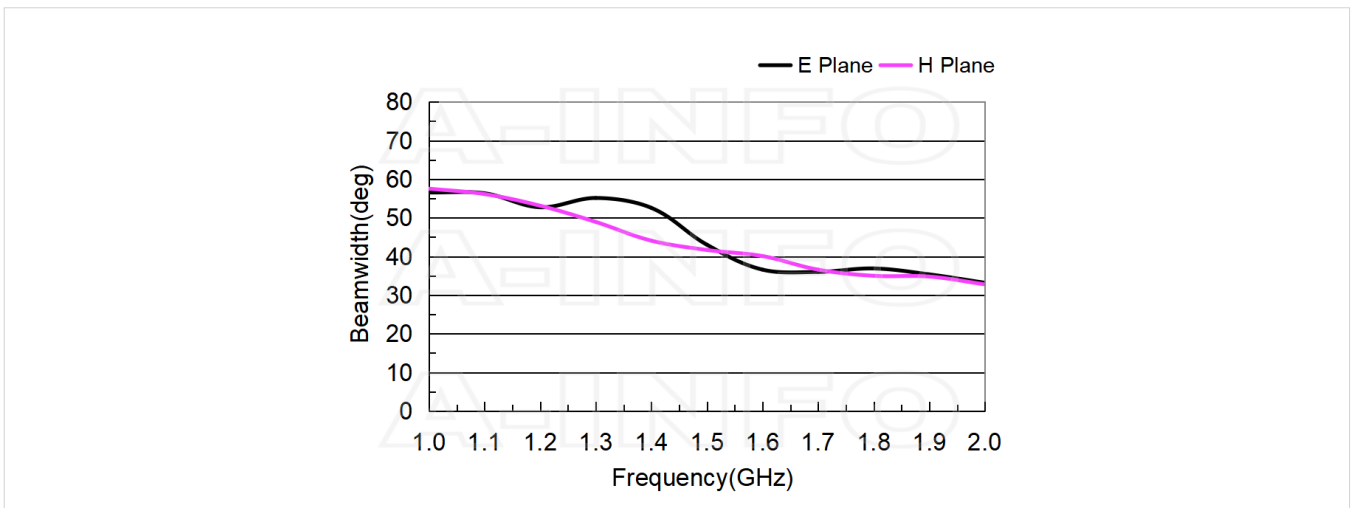

Pattern

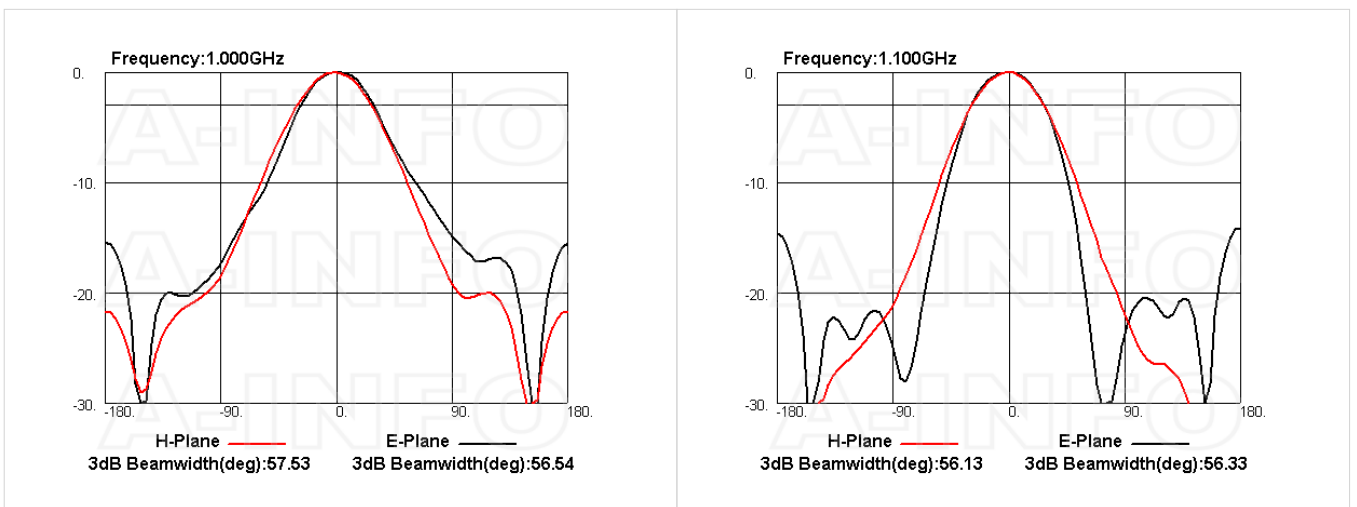

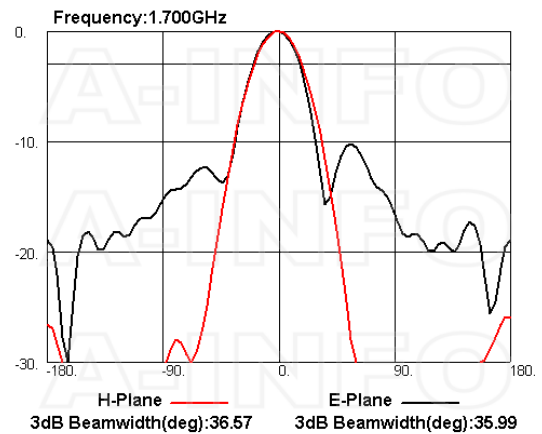
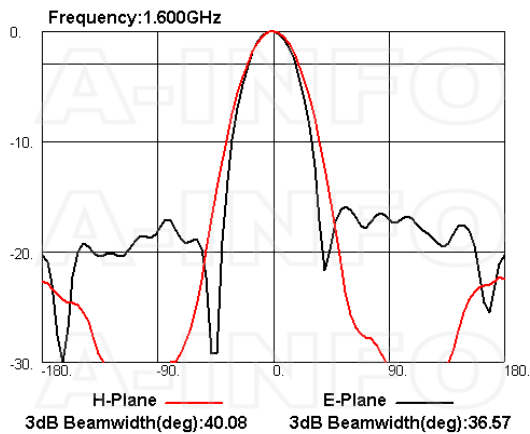
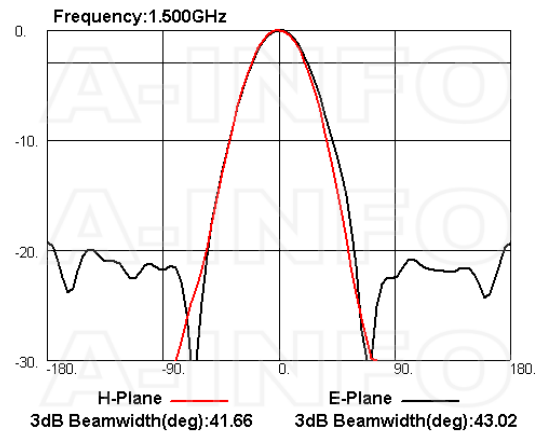
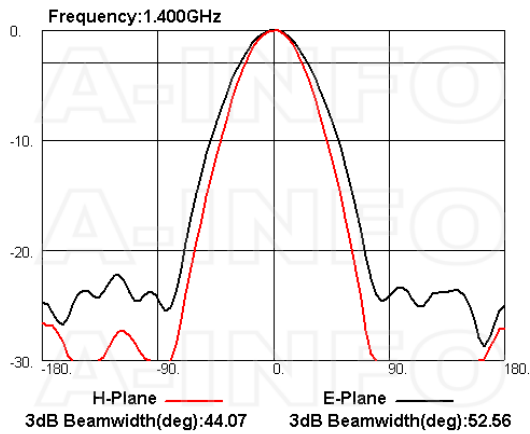
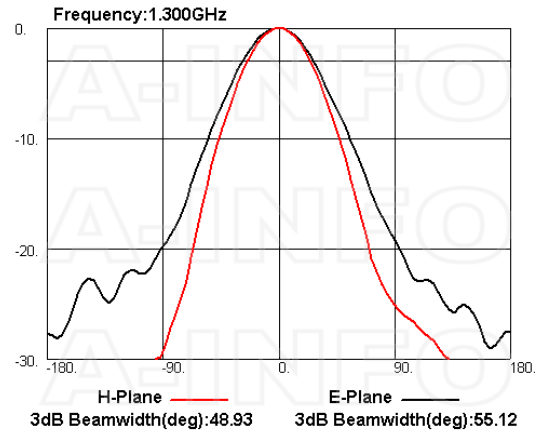
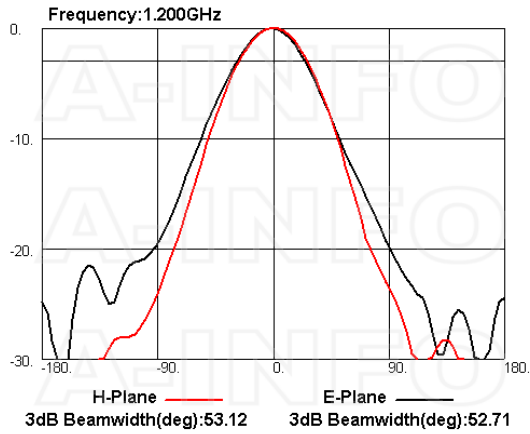

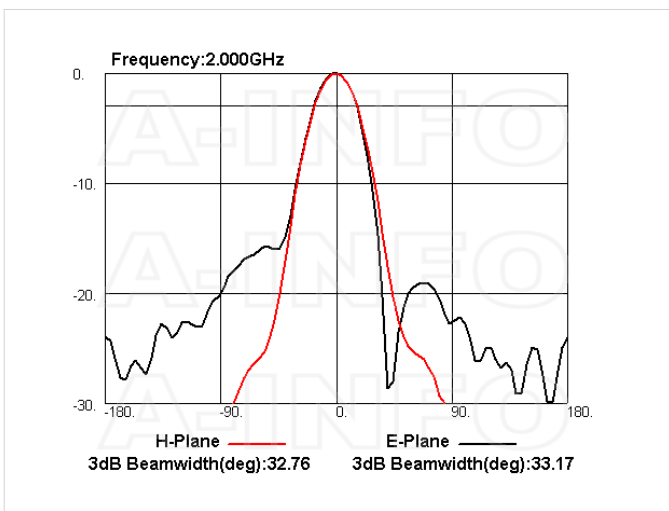
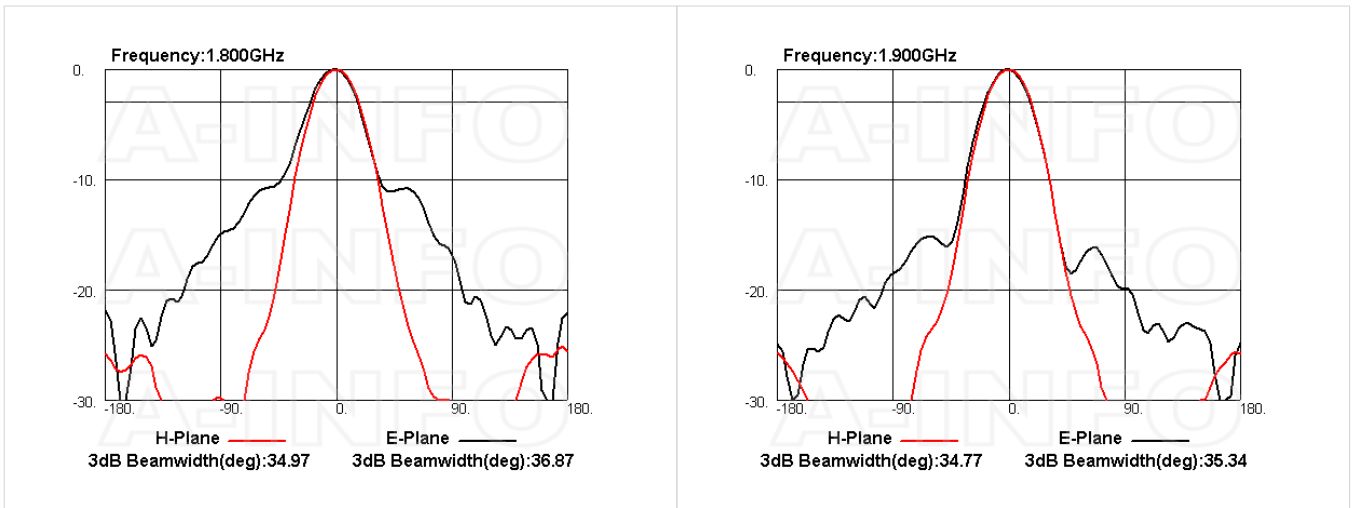

Related Products



LB-650-10-C-MB Round Type Mounting Bracket



LB-650-10-C-L L type mounting bracket



Carrying Case_LB-650-10-C Al Alloy Carrying Case

Similar Products



LB-OH-650-10-C-NF Octave Horn Antenna 1-2GHz 10dB Gain N Type Female



LB-OH-650-10-C-NFSPO Octave Horn Antenna 1-2GHz 10dB Gain N Type Female



LB-OH-650-10-C-SF Octave Horn Antenna 1-2GHz 10dB Gain SMA Female

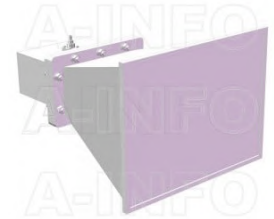

LB-OH-650-10-C-SFSPO Octave Horn Antenna 1-2GHz 10dB Gain SMA Female



LB-OH-650-10-C-7/16F Octave Horn Antenna 1-2GHz 10dB Gain 7/16 DIN Female

About this Datasheet

<ul style="list-style-type: none"> ● Product Information Product Link: https://www.ainfoinc.com/lb-oh-650-10-c-7-16fspo-octave-horn-antenna-1-2-ghz-10db-gain-7-16-din-female Data subject to change without notice. © A-INFO INC. 2024. All Rights Reserved 	<ul style="list-style-type: none"> ● Contact Us Address: 60 Tesla, Irvine, CA 92618, USA Website: www.ainfoinc.com Email: sales@ainfoinc.com 	<ul style="list-style-type: none"> ● Phone & Fax Phone: +1-949-639-9688 +1-949-639-9608 Fax: +1-949-639-9670
---	--	---